



HEXINVERTER.NET

Mutant Hot Glue

analog bus mixer with compression and distortion

DIY ASSEMBLY MANUAL v1.05

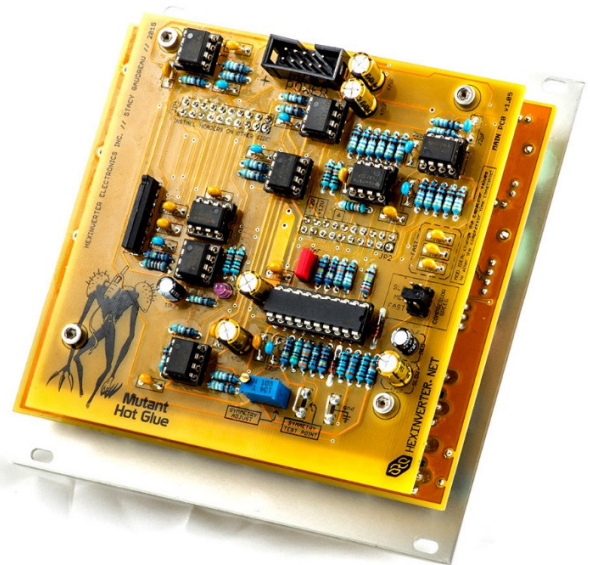

CONTENTS

INTRODUCTION	3
EURORACK KIT ASSEMBLY	3
STEP_00: Resistors + Diodes.....	4
STEP_01: IC Sockets	6
STEP_02: Power Header, Capacitors + Purple LED.....	7
STEP_03: Pin Headers	8
STEP_04: THAT2180, Test Points + Jumper	9
STEP_05: Take a break!	10
STEP_06: Prepare the Potentiometers	10
STEP_07: Place the Parts	11
STEP_08: Panel Fitment.....	12
STEP_09: Jacks + Toggle Switch	13
STEP_0A: LEDs + Trim Pot.....	14
STEP_0B: Align + Solder	15
STEP_0C: Install ICs.....	16
STEP_0D: Assemble the PCB Sandwich.....	17
STEP_0E: Looking good!	18
STEP_0F: Compressor Calibration.....	19
STEP_10: Knobs, Shafts + Nuts.....	21
STEP_11: R.T.F.M.....	22

INTRODUCTION

Thank you for your interest in/purchase of the Mutant Hot Glue DIY project! It is my hope that you find this design a useful addition to your modular synthesizer.

This assembly manual will show you how to build your Mutant Hot Glue module in the eurorack modular format. This project is designed as a eurorack module and thus **there are no provisions made for other formats, though, adapting is not impossible for the skilled builder.**

The Mutant Hot Glue is not especially difficult to assemble, but, you will probably benefit from having a few DIY projects under your belt before beginning on this one.

The regular assortment of hand tools are needed: a 2.5mm hex allen key, various sockets, a knurled nut driver for the jacks, solder, a good bench-top soldering station (50 to 70W recommended). Besides that, a relatively accurate digital storage oscilloscope (DSO) makes calibration of the compressor circuit the most accurate, but you could also use an O'Tool or other DSO alternative, without too much of a difference.

A huge thank you to Hannes Pasqualini of papernoise.net for his excellent graphics design and artwork used for this project! (<http://papernoise.net>)

















If you are building a PCB+panel set for which you sourced your own components, please note that your parts may not exactly match ours shown in the following procedures. Because the Hot Glue is a full kit project, our focus will primarily be to aid the kit builders in this manual.

EURORACK KIT ASSEMBLY

I recommend following the steps outlined here if you haven't built many modules before. If you are an experienced builder, you could probably just give a read through these steps to catch any possible traps ahead of time.

We're going to be assembling both of the PCBs at the same time, so get your tools and parts ready and let's go!

- First, install the diodes. *The band on the diode matches the band on the PCB silkscreen.*
- Diodes are polarity sensitive. It is critical that you install them the right way or the circuit will not work properly!
- **It's a good idea to set aside your resistor lead clippings for later when we install the test points**
- Next, install the resistors. The resistor colour codes for 1% metal film (as supplied in the kits) are as follows...

51R 	470R 	1k91 	4k99 
5k1 	10k 	12k4 	24k 
33k 	57k6 	100k 	169k 
200k 	300k 	383k 	576k 
2M 			

STEP_02: Power Header, Capacitors + Purple LED

- First, install one of the purple LEDs into its place on the MAIN PCB. *The longer leg is positive (+) and must align to the '+' marking on the PCB*
- Up next are the ceramic disc and film capacitors. These are the yellow and blue blobs, and the red box. They can be installed in any direction
- The power connector should be installed next, making sure that it is installed in the right orientation (as shown)
- The electrolytics can be installed now. *The negative (-) strip on the capacitors must be aligned with the shaded (black) semicircle area on the PCB silkscreen. Just like the LED, the positive (+) leg is the longest.*

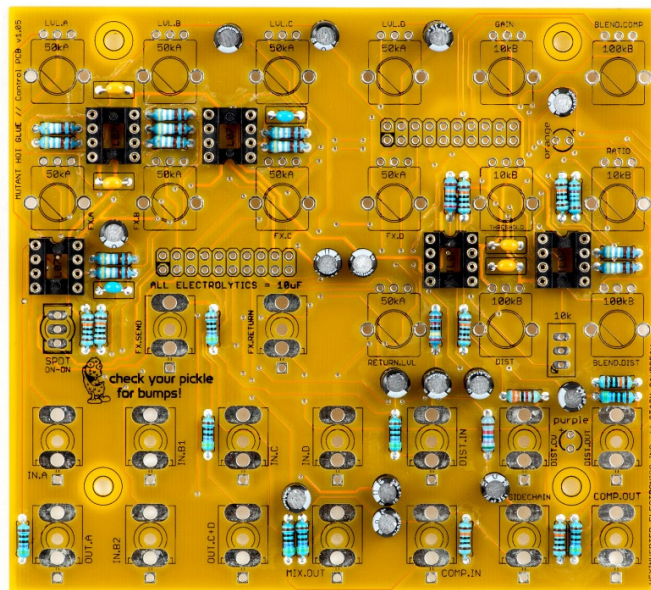
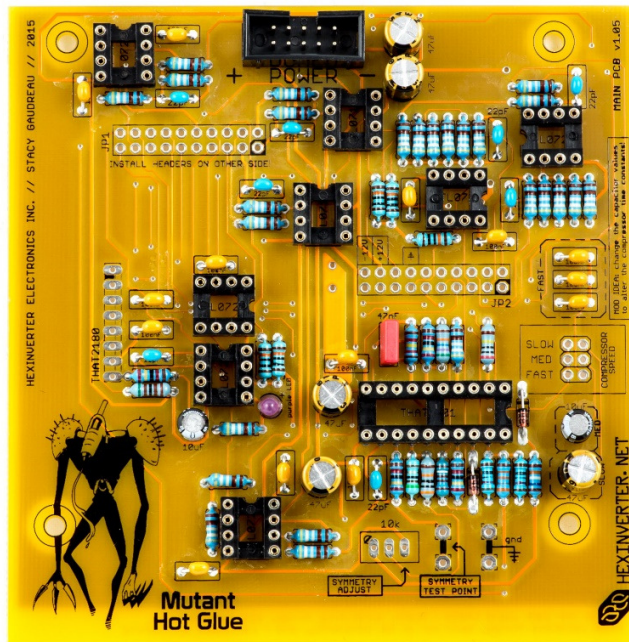

STEP_03: Pin Headers

- Begin by using pliers to snap the 2x40 pin headers into (2x) 2x10 sections and (1x) 2x3 section, as shown. We included an extra 2x40 header in case you have an accident, or some snapped during shipment.

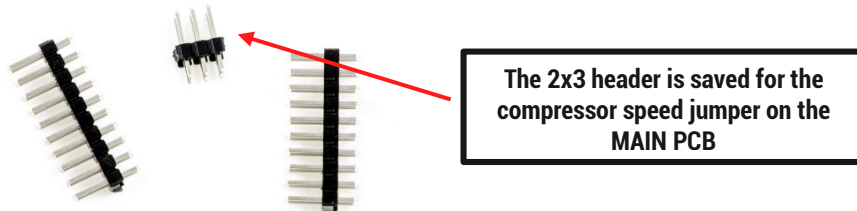

- Install the headers in the PCBs, **making sure to install the female headers on the CONTROL PCB** (not the MAIN PCB). This is because the longer profile of the female headers will interfere with component pins on the MAIN PCB.
- Take your time checking alignment before and during soldering. You want to make sure that the

Take your time checking alignment before and during soldering of the pin headers. You want to make sure that the PCBs line up nicely so that the standoffs+screws that hold the PCB sandwich together are aligned properly. *It might be a good idea to screw the PCBs together while you solder the pin headers, if you want to guarantee they are aligned well!*

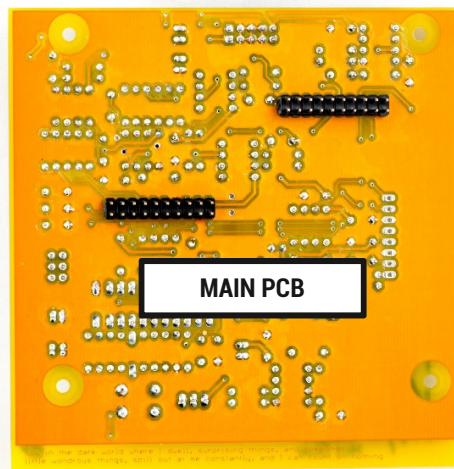
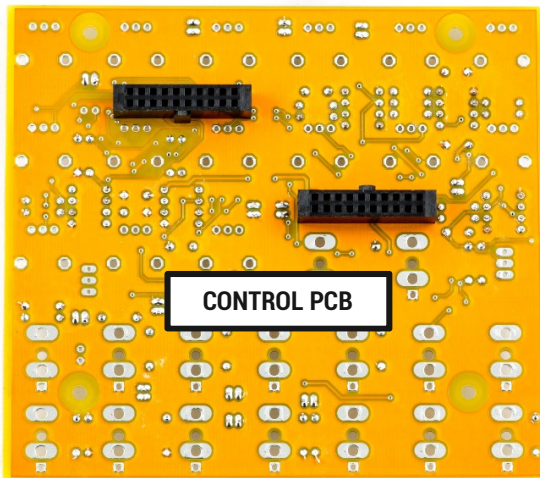

STEP_04: THAT2180, Test Points + Jumper

- After installing the jumper on the 2x3 pin header we cut up in the last step, you can solder it in for the COMPRESSOR SPEED jumper.
- Using a couple of left over component lead clippings, bend them into a 'U' shape which fit in the **gnd** and **SYMMETRY TEST POINT** locations, at the bottom right of the MAIN PCB.
- Solder in the 10k trim potentiometer for the SYMMETRY ADJUST calibration point
- Finally, solder in the THAT2180 VCA chip. *Be careful not to overheat it, and make sure the notch is aligned where indicated!*

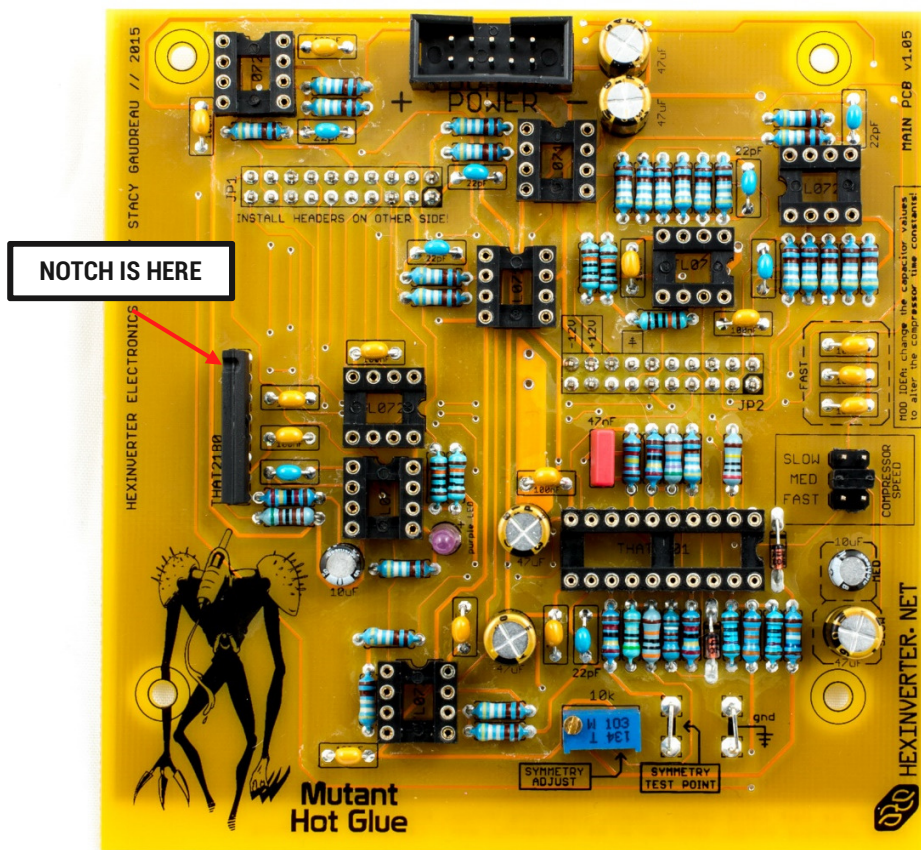

STEP_05: Take a break!

- It is almost time to assemble the control surface (yay)!
- But, first: look over the two PCBs you just populated and make sure there are no missing or shorted solder joints. You don't want to put it all together and then find out you missed a few spots with the iron! If you're anything like me, it happens more often than you'd like to admit (I'm not actually a robot...hehe)
- If you are feeling tired or rushed, it might be a good idea to rest up before coming at it again. The control board is for sure the hardest part of assembly and you don't want to mess it up! So have a fresh, well-rested mind for this final section.

STEP_06: Prepare the Potentiometers

The included BI Technologies potentiometers all need their locking clip cut off. Grab a pair of sharp cutting pliers and clip off the little tab of metal on each pot, as shown. **Wear eye protection and try to prevent the clippings from flying all over, by cupping your hand over the cut as you make it!** These little bits go flying off in all directions very fast when clipping.

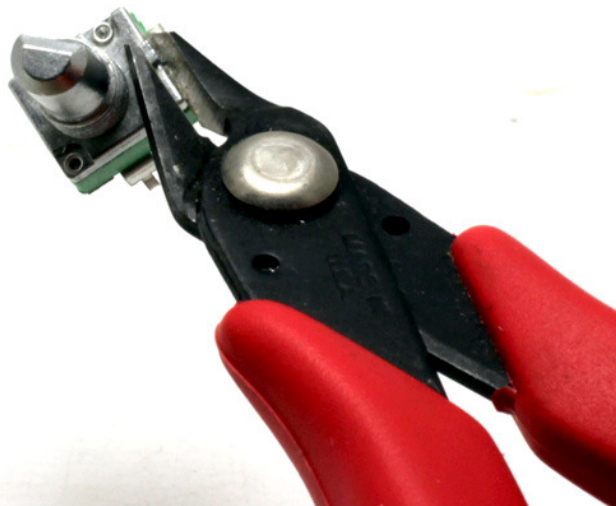

STEP_08: Panel Fitment

Remove the protective covering from the panel and install it on the loose-fitting control board components. Finger tighten the nuts for a few of the potentiometers. Do not solder anything yet!

The potentiometers set the height the panel is at. That is, all of the other components follow the height of the potentiometers. This means you have to align and solder the potentiometers first, before the other components are soldered!

Make sure everything is sitting nice and flat on the PCB and especially that the pots are seated flat. Once you are happy, flip the assembly over and solder one leg of each pot. Then inspect and reheat any pots that aren't perfectly flat, pushing them down flat on the PCB with your finger while you reheat the one leg you soldered.



STEP_09: Jacks + Toggle Switch

- Gently flip the control board with panel attached over so that the jacks fall down with gravity against the panel. Sit the assembly gently on your desk and **inspect to see that each jack is flush with the back of the panel.**
- The jacks will be slightly lifted off of the PCB. Try to ensure that they are flush with the panel.
- Unscrew the nut for the toggle switch slightly, to raise it to the same height as the panel.
- When you are happy with the fit, solder each jack and toggle switch, going back to check that they are nicely against the panel each time.

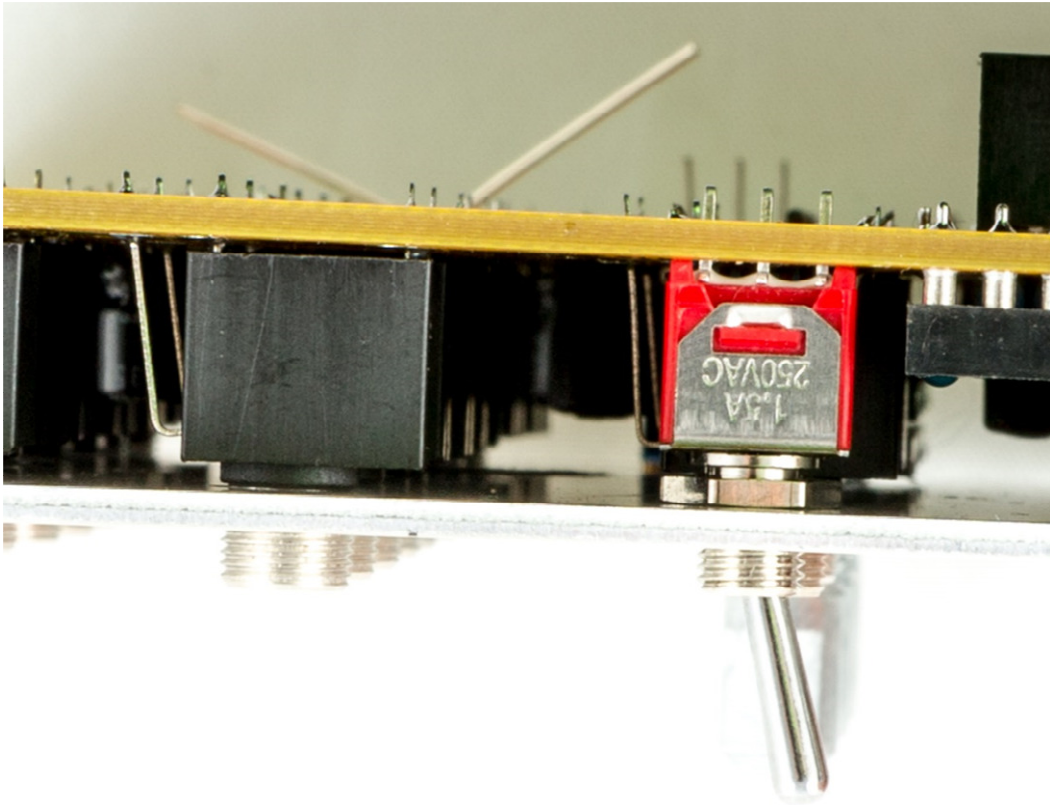

STEP_0A: LEDs + Trim Pot

- Remove the nuts holding the panel to the components you just soldered
- Loosely fit the purple and orange LEDs in their places, making sure to install the longer lead to the positive (+) indicator on the PCB
- Fit the remaining 10k trim pot in its place on the CONTROL PCB (don't solder it yet!)

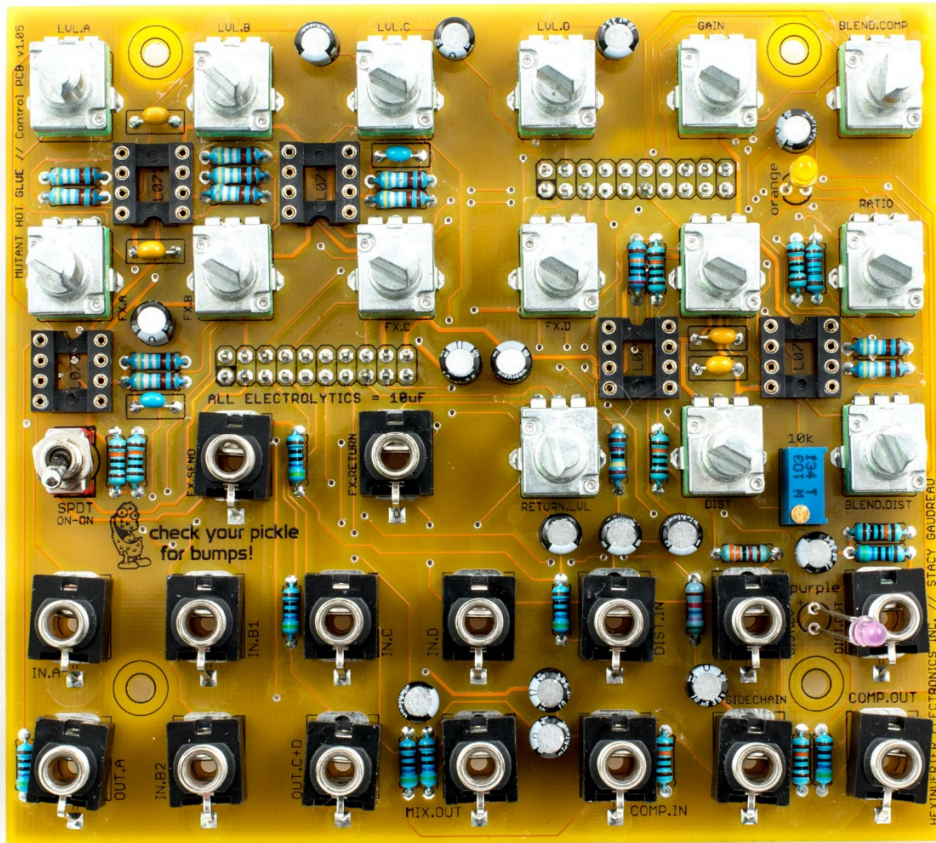

STEP_0B: Align + Solder

- Once again, fit the panel to the CONTROL PCB using only a few nuts
- Carefully align and solder the LEDs and trim pot so that they fit the panel properly



STEP_0C: Install ICs

- It's time to install the ICs in their sockets!
- Be careful to install them in their correct orientation. If they are reversed when you power on the module, the chips may be destroyed.

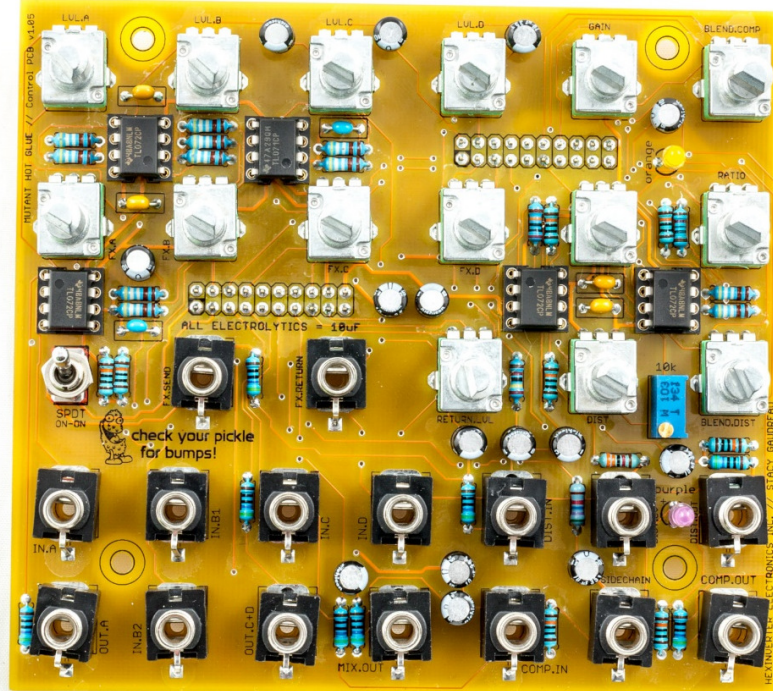
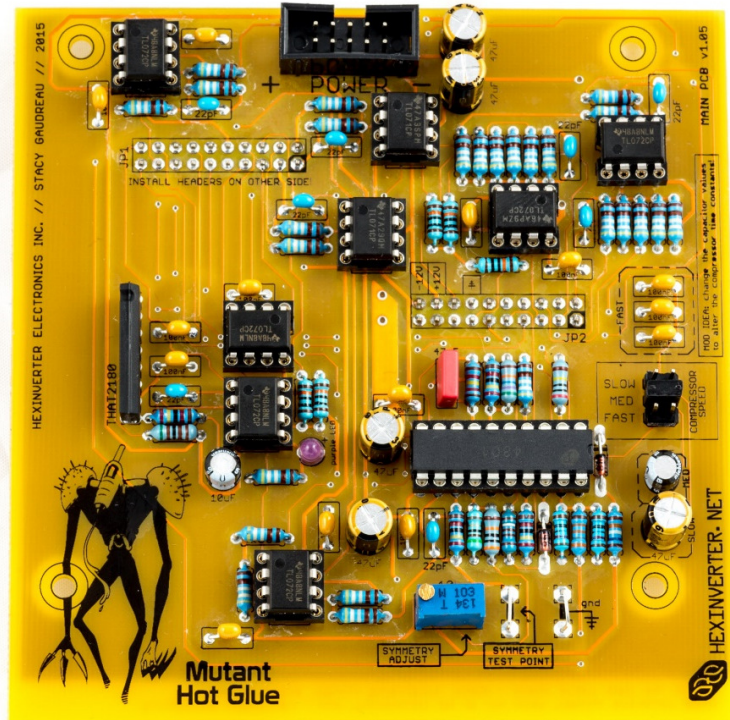

STEP_0D: Assemble the PCB Sandwich

- It's probably a good idea to give each PCB a final inspection for obvious errors before moving on!
- Using the (8x) M3 screws and (4x) black nylon standoffs, it's time to put the PCB sandwich together.
- It is recommended to first mount the standoffs tightly onto the CONTROL PCB, and then you can place the MAIN PCB on top of that and screw it in a little more gently. *This will make it easier should you have to unscrew the MAIN PCB later – it should avoid accidentally loosening the CONTROL PCB's screws from the standoffs at the same time as the MAIN PCB's screws.*

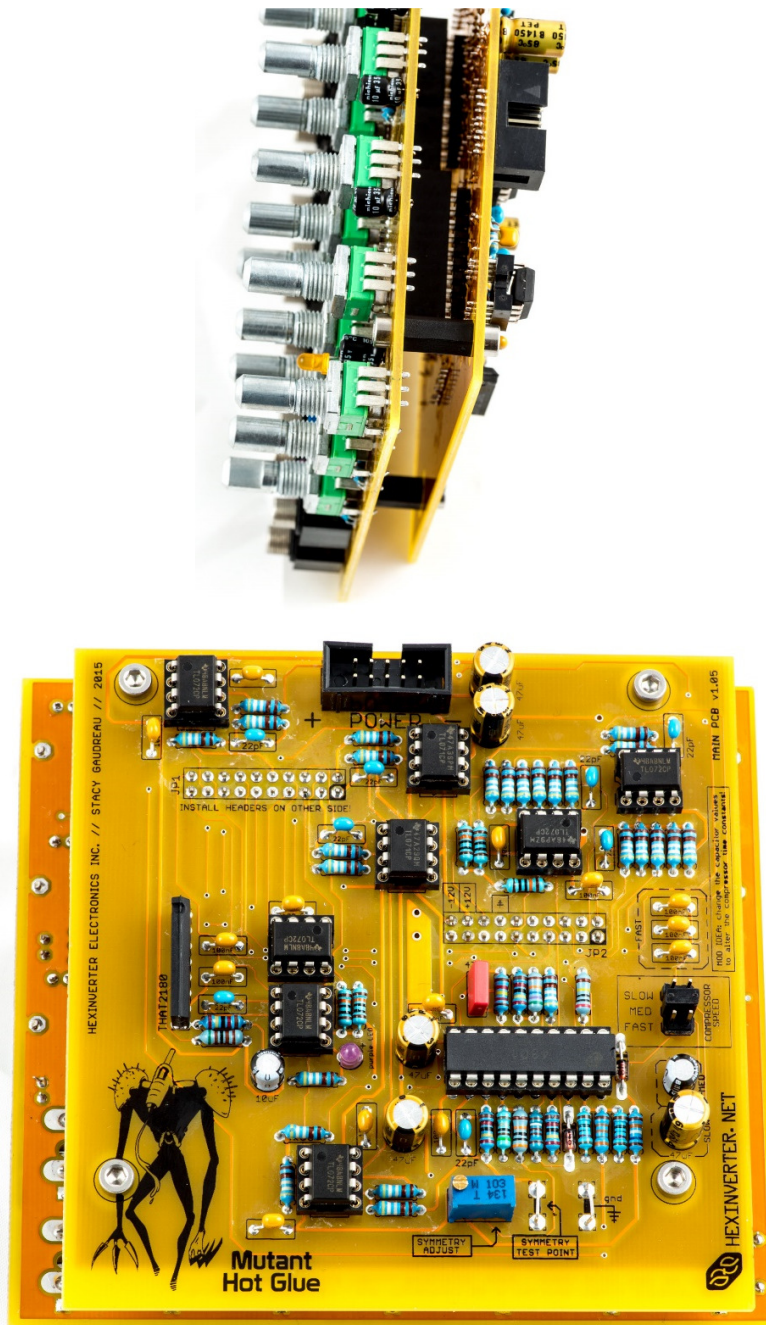

STEP_0E: Looking good!

- Almost done! Sit back and enjoy your work for a second.
- Apply power to your module to make sure nothing gets hot or lights on fire. Does everything work okay?
- If you don't care about having a perfectly distortion-less compressor, go ahead and skip the next step: **STEP_OF: Compressor Calibration.**

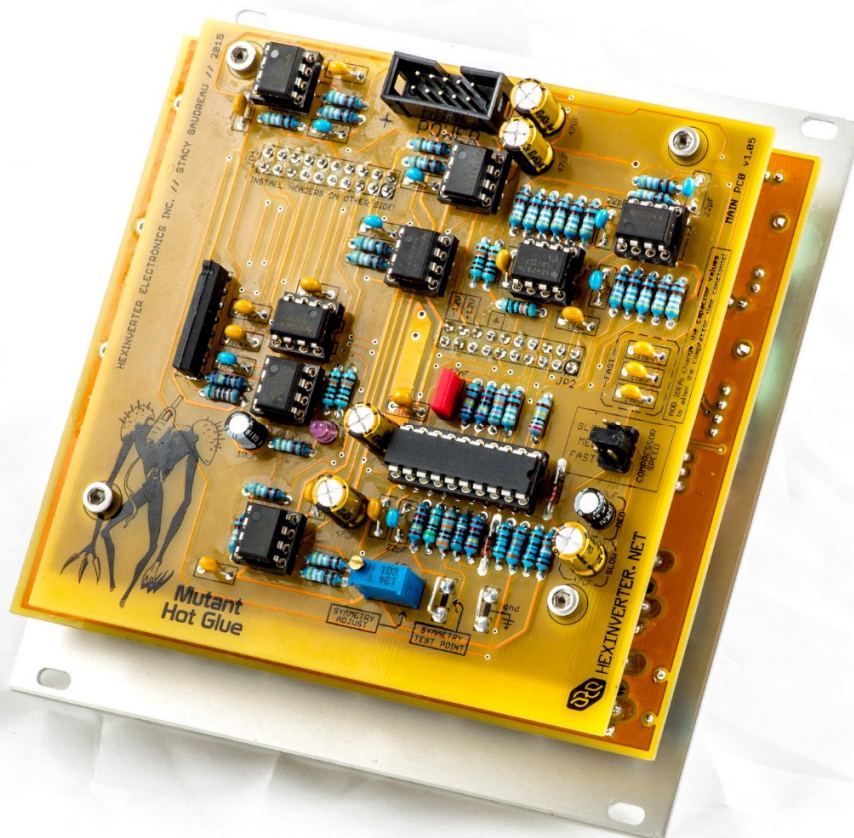

STEP_0F: Compressor Calibration

- The THAT4130 Dynamics Engine IC, which is the heart of the analog compression circuit, benefits from having its symmetry bias trimmed for least distortion. **You can use the module just fine without it, but the audio passed through the compressor will have its symmetry distorted somewhat.**
- If you do not own a function generator and oscilloscope, you can use a sine wave oscillator and something like the Jones O'Tool module
- **If you use a sine wave oscillator:** try to use the most symmetrically accurate one you have – digital is probably best for symmetry. We don't care about vertical resolution/bits of the waveform here, so there is no benefit to analog – it's the symmetry you want to look out for during this test.

STEP 0: Begin by generating a sine wave, as shown below. Insert this sine wave into the Compressor IN jack.

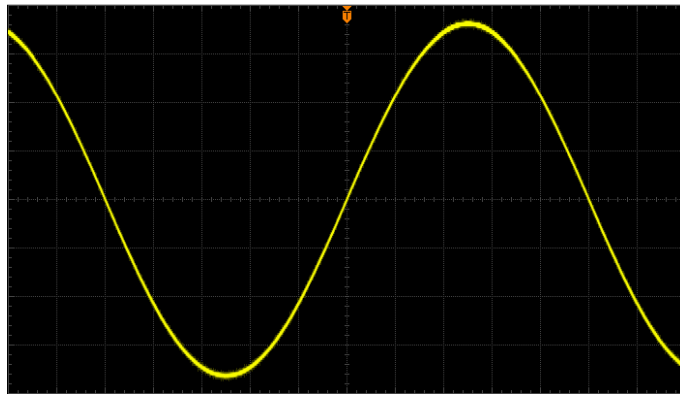

Use a sine wave around 8Vpp @ 1kHz – exact numbers are not important, but, **do make sure it is centered symmetrically about 0V!**

STEP 1: If you are using an oscilloscope, clip your probe to the **gnd** and **SYMMETRY TEST POINT** clips on the back of the module which you installed earlier. If you are using an O'Tool, patch into the COMP output.

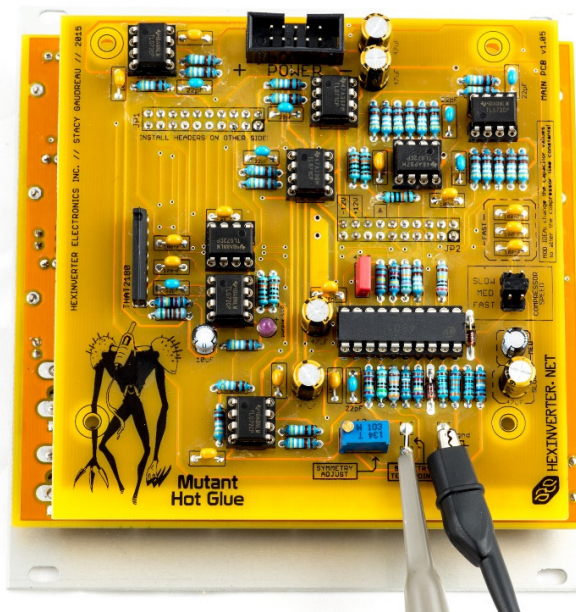

STEP 2: Deactivate the compressor's gain reduction, with the following settings...

GAIN = 0dB
BLEND = WET (100%)
THRESHOLD = +26dBu
RATIO = MAXIMUM

STEP 3: While viewing and comparing the COMP output signal to the input signal, adjust the **SYMMETRY ADJUST** control for best vertical symmetry. See the images below for how to do this...

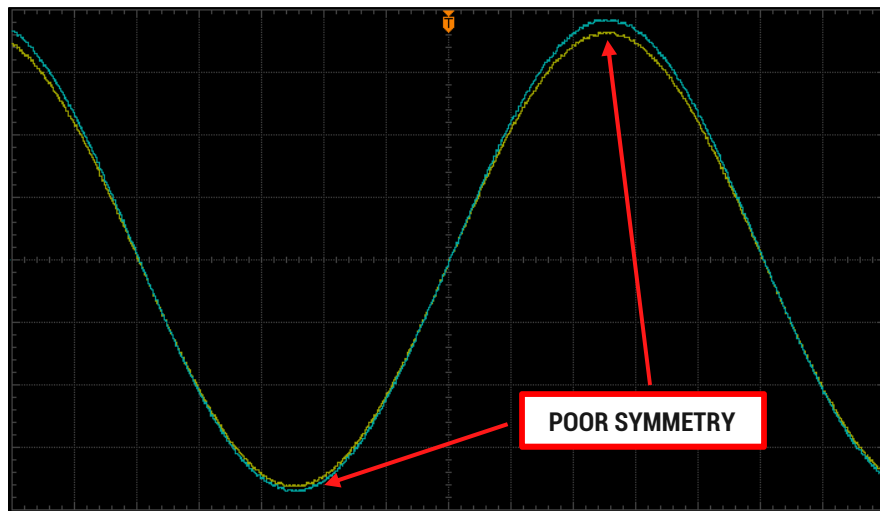

The upper and lower peaks of the output waveform (blue) are not symmetrical. You can tell by inspecting the vertical distance between the yellow and blue waveforms.

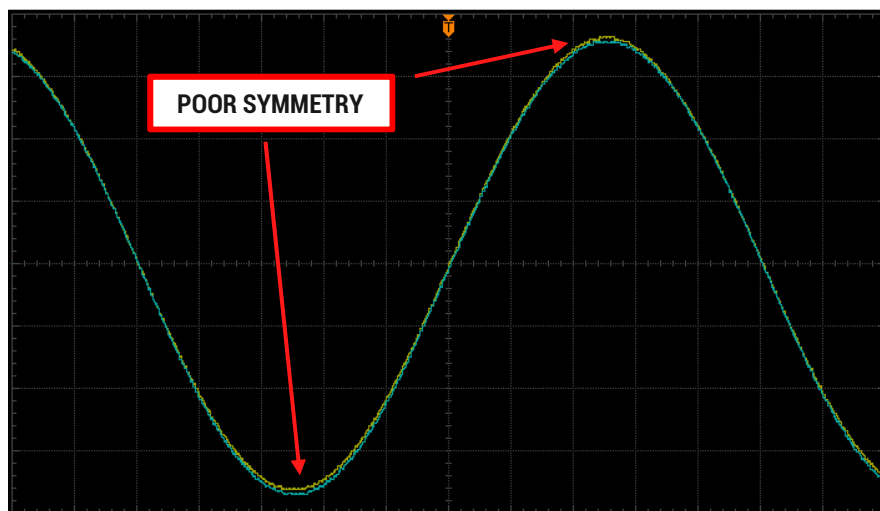

*At first glance, this might seem okay – but pay close attention! – the output waveform (blue) is **above and below** the input waveform! This is not correct, as we will see in the following correct example.*

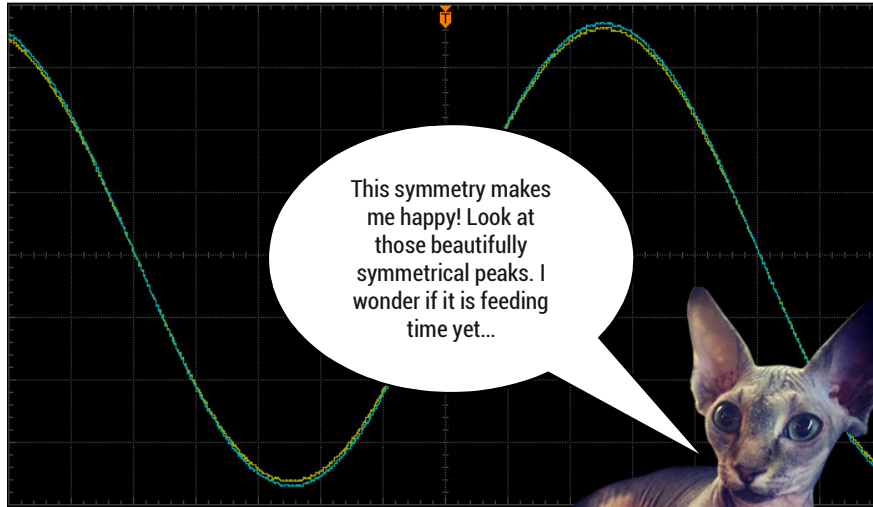

This is what good symmetry looks like. As Tau pointed out, the blue (output) channel's peaks are displaced equal distances from the yellow (input) peaks – unlike the previous two examples.

STEP_10: Knobs, Shafts + Nuts

- Once you are confident that your Mutant Hot Glue is working well, the next step is to tighten down all the nuts. Be careful not to scratch the soft aluminum panel with your hard tools of course!
- Once the nuts are on, it's time to press the knobs firmly onto all the potentiometer shafts.



STEP_11: R.T.F.M.

- If you have not already – go check out the User Manual from the HEXINVERTER.NET website! If you're too busy to do that, then maybe print it out and leave it by the toilet for some bathroom reading.
- I sincerely hope you enjoy your new Mutant Hot Glue eurorack module!

MUTANT HOT GLUE
Analog Bus Mixer with Effects

>> 24HP | 35mm DEEP | \$399USD | +70mA, -70mA
>> EURORACK FORMAT MODULE - AVAILABLE NOW
>> ALSO AVAILABLE AS A DIY PROJECT



BUY MODULE

USER MANUAL

MODULARGRID

This thing right here makes for happy times Hot Gluing your hand to your face :)